

# User Manual NSPanel86PB-Relay / NSPanel86PW-Relay (EN)

---

## Introduction

### Features

### Compatible Voice Assistants

### Specification

## Installation

### 1. Power off

### 2. Wiring instruction

### 3. Installation

## Function Guide

### Log In to eWeLink Account

#### 1. Power on

#### 2. Log in

### Add Zigbee Devices

#### 1. Pairing mode entry

Method 1: Entry on the central control panel.

Method 2: Entry on the eWeLink App.

#### 2. Set the Zigbee device into the pairing mode and complete the adding by following the prompts.

### Add Wi-Fi Devices

### Matter Bridge

Method 1: Pair via Matter Bridge on the NSPanel Pro Gen2 & Sync Devices via App

Method 2: Pair via Matter Bridge in eWeLink App & Sync Devices

### F-Droid

### Home Assistant App as Home App

### Enable & Add Central Heating

Enable Central Heating:

Method 1:

Method 2:

[Add Central Heating:](#)

[Add Camera & View Camera](#)

[Method 1: Add Camera via the NSPanel Pro Gen2 Screen](#)

[Method 2: Add Camera via the eWeLink App](#)

[View Camera Feed](#)

[Smart Security](#)

[Factory Reset](#)

[Method 1:](#)

[Method 2:](#)

[EU Declaration of Conformity](#)

[For CE frequency](#)

[EU Operating Frequency Range](#)

[EU Output Power](#)

[WEEE Disposal and Recycling Information](#)



Smart Home Control Panel (Dual-Channel Relay)

User Manual v1.0

## Introduction

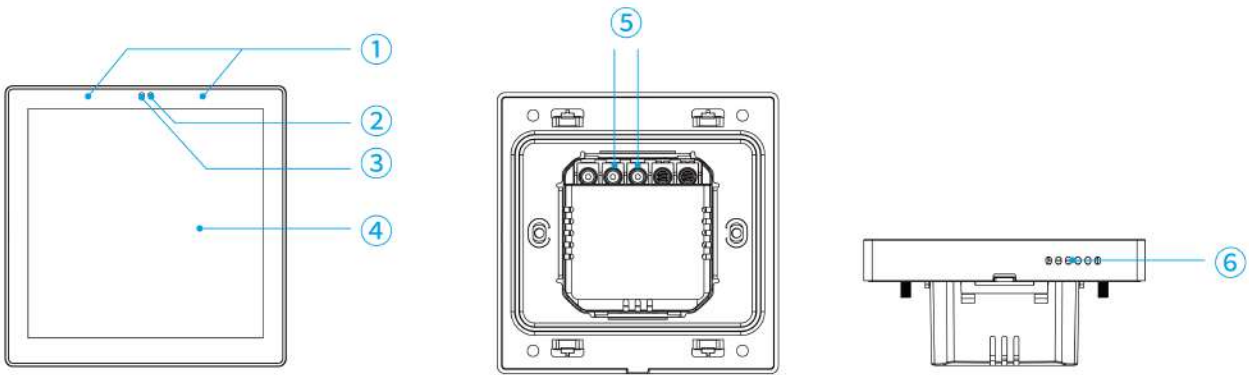

① Microphone	② Proximity Sensor	③ Light Sensor
④ 3.95" Capacitive Touchscreen	⑤ Dual-Channel Relay	⑥ Speaker

\*Device Weight: < 1kg

\*Recommended Installation Height: < 2 m

## Features

NSPanel Pro Gen2 is a smart wall panel designed to unify your entire home. It seamlessly integrates device control, environment regulation, security monitoring, and intuitive touch interaction into one elegant interface—becoming the visual command center of your smart home.

### ● Whole-Home Control at Your Fingertips

Adjust lights, curtains, air conditioning, and room temperature through a sleek visual interface. Customize your dashboard with widgets to create a personalized control panel tailored to your needs.

### ● Dual-Channel Relay, Direct Local Control

With built-in dual-channel relays, it can directly control two wired devices, enabling stable and reliable local on/off operation even without an internet connection.

### ● Zigbee & Matter Bridge Built-In

Equipped with a built-in Zigbee gateway, it supports stable connectivity with a wide range

of Zigbee devices. With the Matter Bridge, effortlessly integrate and control devices across different smart home ecosystems.

### ● Home Assistant Dashboard & Camera View

Fully compatible with Home Assistant, serving as a dedicated touchscreen interface.

Supports real-time camera monitoring—view live feeds directly on the panel for enhanced security and peace of mind.

### ● Central Heating Control System

Supports multiple temperature and humidity sources, allowing simultaneous monitoring and control of temperatures in multiple rooms. It can also activate connected devices to achieve consistent temperature throughout the home.

### ● Open Ecosystem with F-Droid

Unlock the full potential of your NSPanel Pro Gen2 with the F-Droid app store, explore a wide range of third-party tools to customize your experience.

### ● One-Tap Security Mode

Preset three security modes—Away, Home, and Sleep—for quick and easy arming. One tap activates whole-home protection, keeping your family safe at all times.



Built-in Zigbee Hub



Smart Scenes



Home Security



Arm/Disarm



Matter Bridge



Home Assistant



F-Droid



Central Heating



View Camera Live



Smart Home Control



Alarm Clock Setting



Wallpaper Theme  
Switching

## Compatible Voice Assistants



## Specification

NSPanel Pro Gen2	
Product series	NSPanel Pro Series
Product name	Smart Home Control Panel
Model	NSPanel86PB-Relay, NSPanel86PW-Relay
CPU	Quad-core ARM Cortex-A35 CPU
GPU	Mali G31-2EE GPU
Soc	RK3326-S
RAM	2 GB
Storage	32 GB
Rating	100-240V-50/60 Hz MAX 5A/Gang 10A/Total Resistive load LED: 150W@240V/Gang, 75W@100V/Gang
Wireless connectivity	IEEE 802.11a/b/g/n/ac/ax 2.4G/5G, Zigbee 3.0
Screen size	3.95" (Capacitive touch panel)
Screen resolution	480x480
Touch control	Support multi-touch
Audio output	8Ω, 1.5W speaker
Microphone	Dual Array Digital Microphone
Light sensor	Adjust brightness according to ambient light automatically (IIC light sensor)

Net weight	190g
Applicable place	Indoor
Working temperature	-10°C-40°C
Working humidity	10%~80% RH, non-condensing
Color	NSPanel 86PW-Relay: White, NSPanel 86PB-Relay: Dim Gray
Product dimension	86x86x39.5mm
Casing materials	PC+CRS
Certification	CE/RoHS

## Installation

### 1. Power off

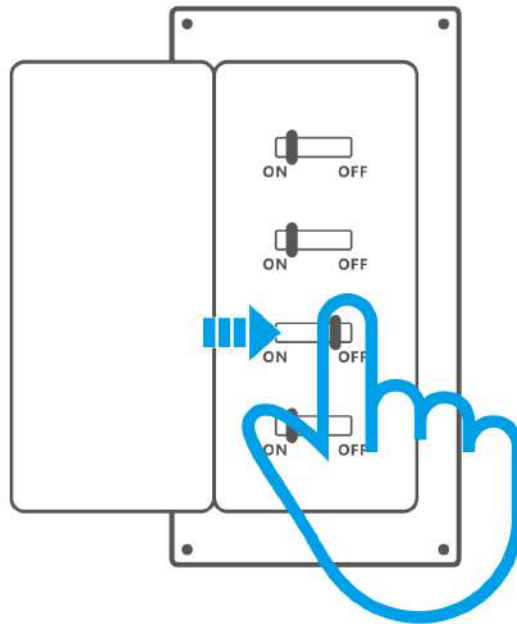

WARNING

1. Please install and maintain the device by a professional electrician. To avoid electric shock hazard, do not operate any connection or contact the terminal connector while the device is powered on!

2. To ensure the safety of your electrical installation, it's essential either a Miniature Circuit Breaker (MCB) or a Residual Current operated Circuit-breaker with Integral Overcurrent protection(RCBO) with an electrical rating of 10A has been installed before the NSPanel86PB-Relay,NSPanel86PW-Relay.

## 2.Wiring instruction

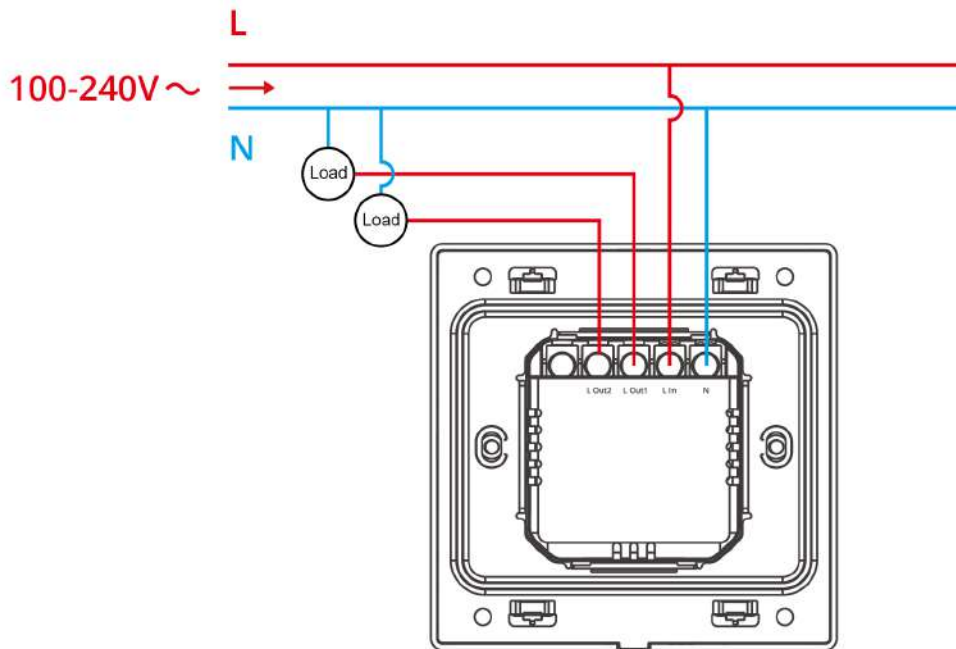

**⚠ Warning:** Please make sure all wires are connected correctly.

## 3.Installation

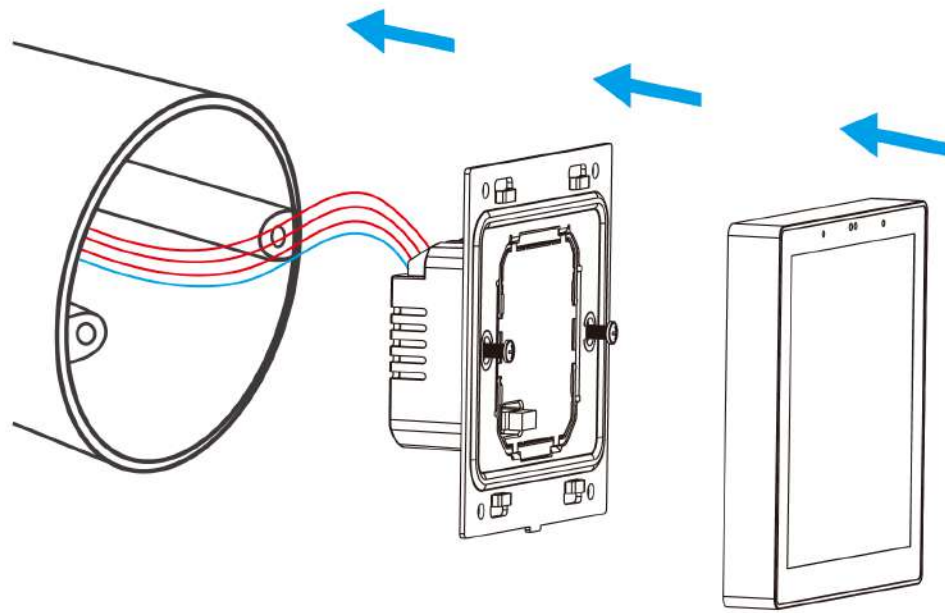

**⚠ Warning:** The product should be installed in the concrete wall or other non-combustible location.

## Function Guide

### Log In to eWeLink Account

#### Download the "eWeLink" App

Please download the "eWeLink" App from [Google Play Store](#) or [Apple App Store](#).



### 1. Power on

After powering on, click "Start," choose the language and region, and then select Wi-Fi and input the password to enter the device's main interface.

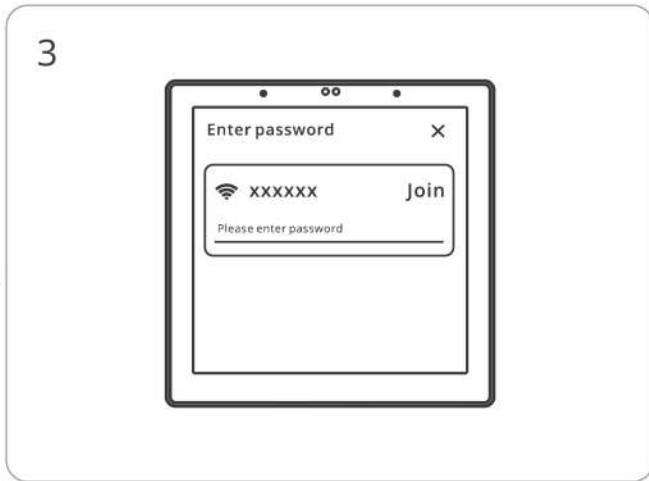
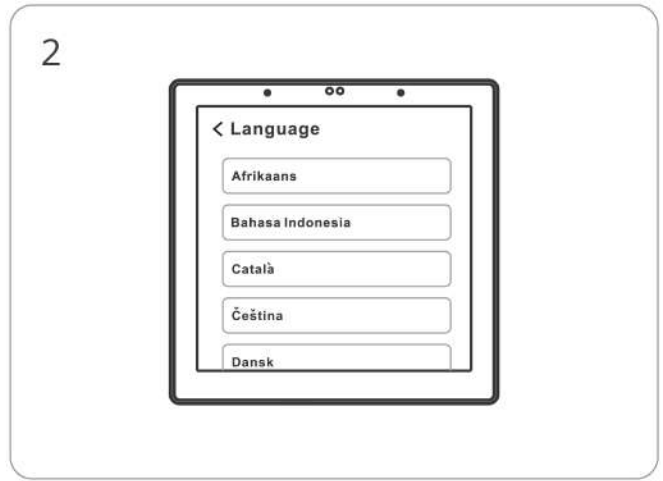

## 2. Log in

Tap "Log in" on the device and tap "+" on the eWeLink App to select "Scan", then scan the QR code on the device screen by your App.

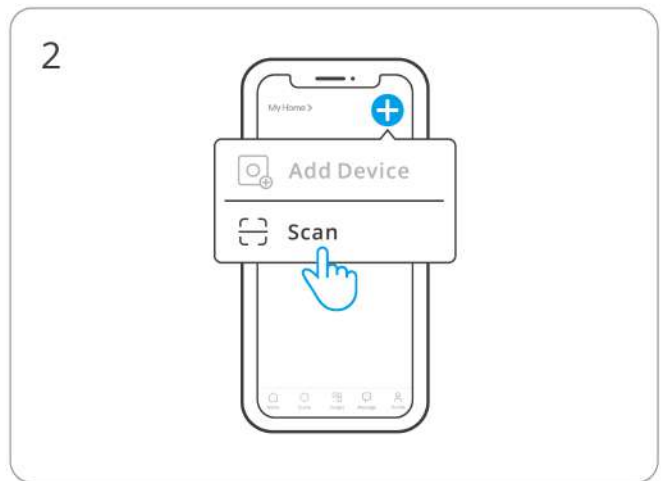
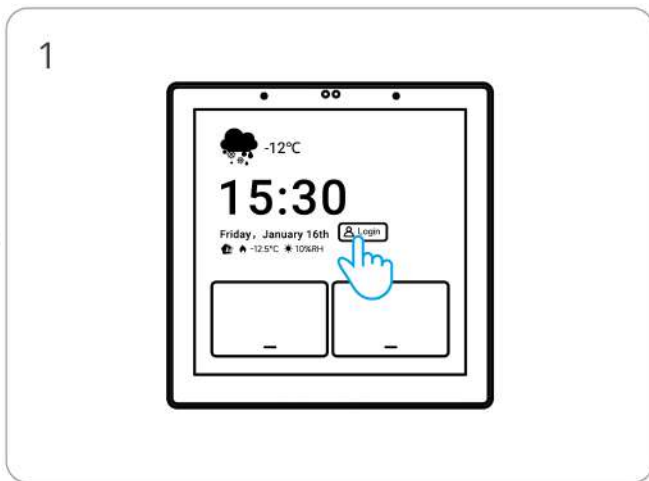

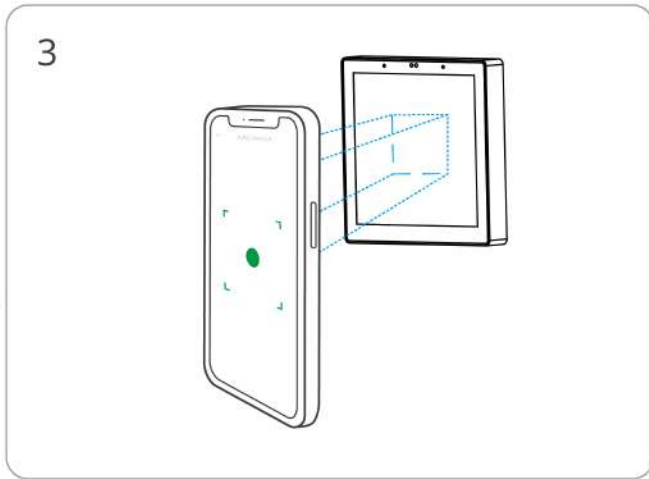

## Add Zigbee Devices

### 1. Pairing mode entry

Method 1: Entry on the central control panel.

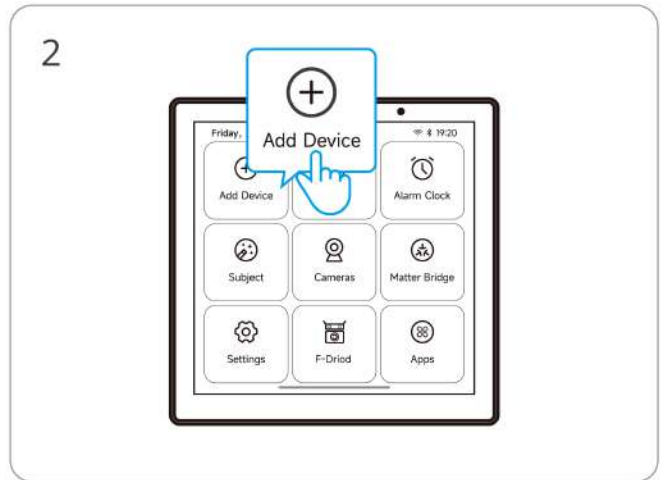
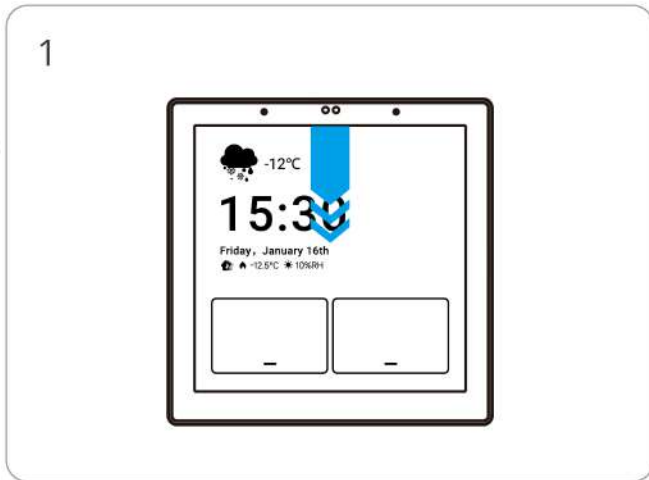

## Method 2: Entry on the eWeLink App.

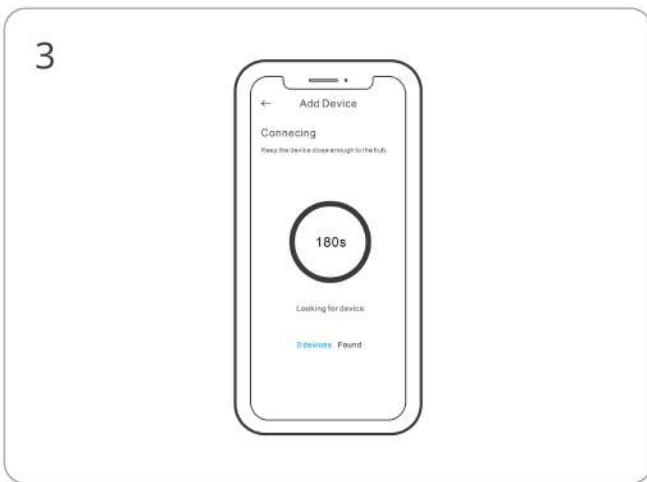
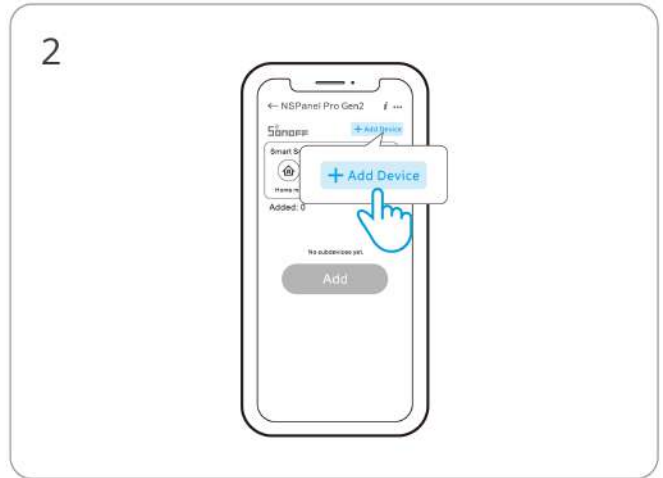
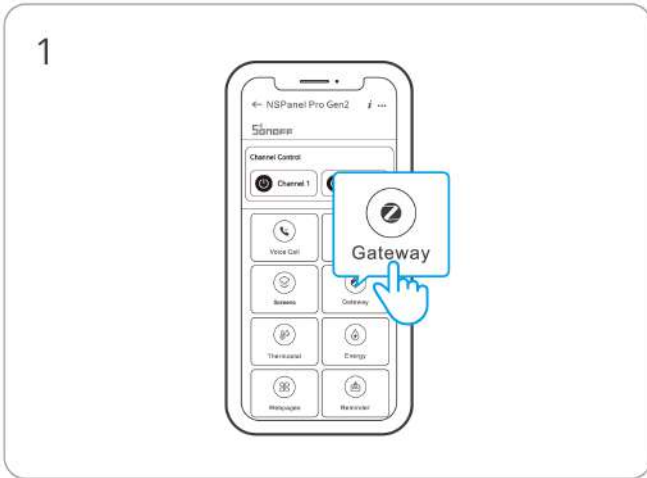

2. Set the Zigbee device into the pairing mode and complete the adding by following the prompts.

## Add Wi-Fi Devices

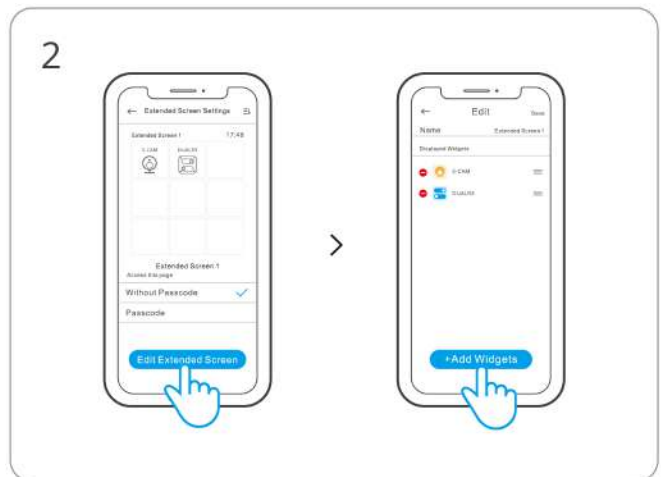
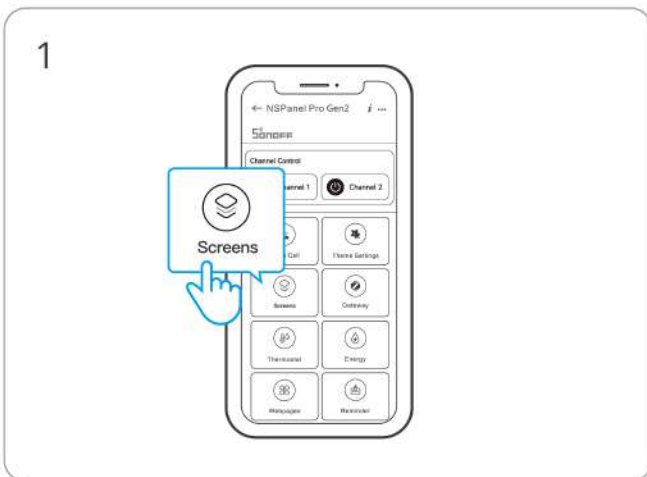

1. Add Wi-Fi devices on the eWeLink App.

2. In the main interface of NSPanel Pro Gen2 on the App, select "Edit Extended Screen" and synchronize the connected Wi-Fi devices to the NSPanel Pro Gen2.

\*After adding the devices, they can be checked and controlled on the panel.

## Matter Bridge

### Method 1: Pair via Matter Bridge on the NSPanel Pro Gen2 & Sync Devices via App

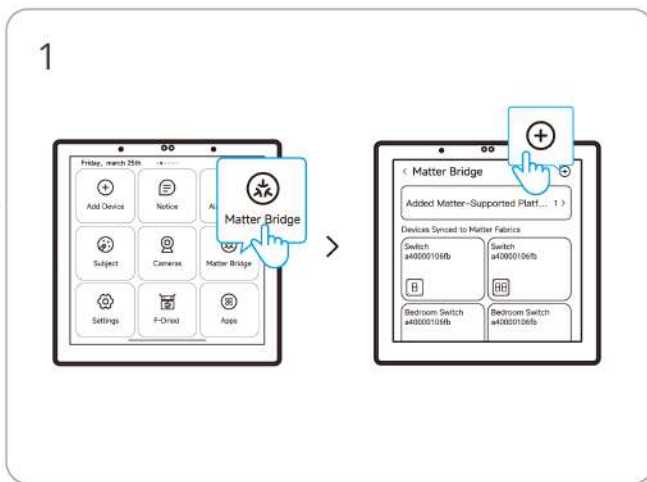

Swipe down on the screen and select "Matter Bridge" to enter pairing mode.

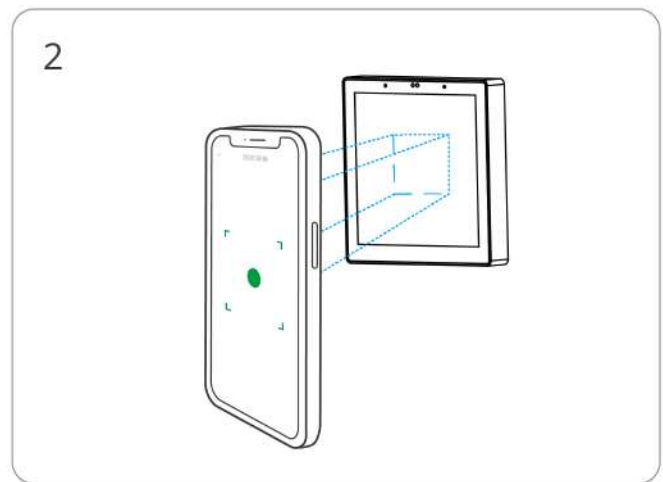

Open a third-party Matter-compatible app, scan the Matter pairing code or enter the numeric code, and follow the on-screen instructions to complete pairing.

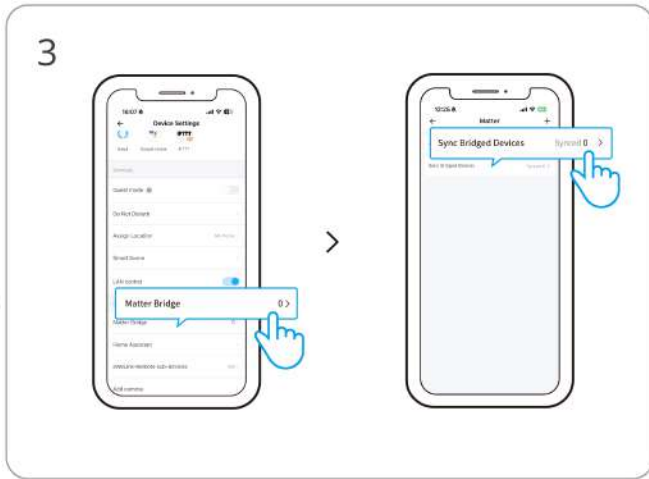

Open the eWeLink app, go to the NSPanel Pro Gen2 device settings page, navigate to **Matter Bridge > Sync Bridged Devices**.

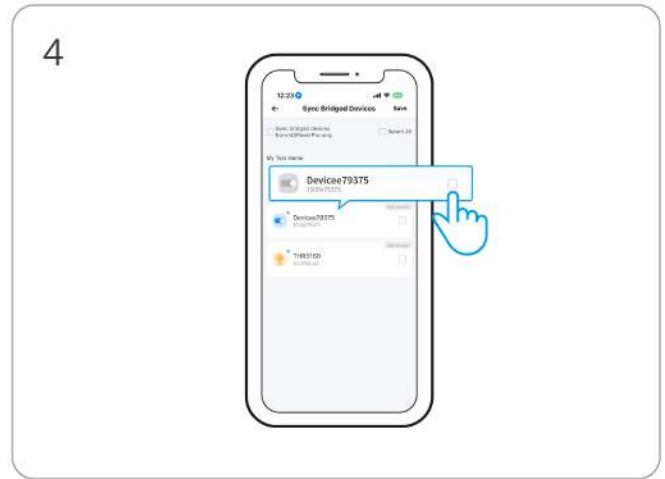

Select and confirm the device to sync it to your added Matter ecosystem.

## Method 2: Pair via Matter Bridge in eWeLink App & Sync Devices

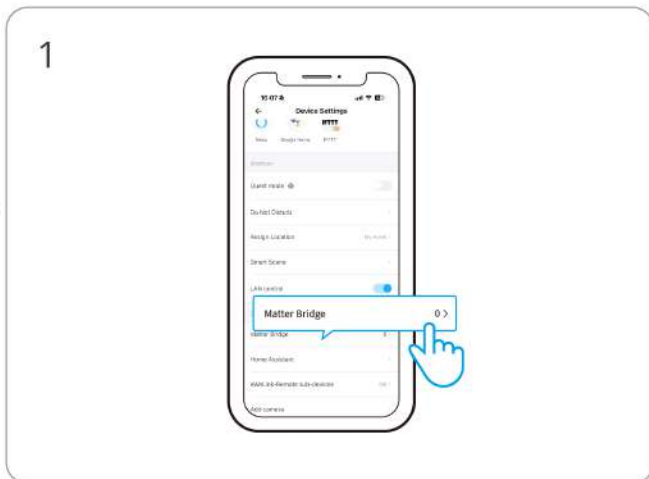

On the NSPanel Pro Gen2 device settings page in the eWeLink app, select "Matter Bridge" to enable pairing mode.

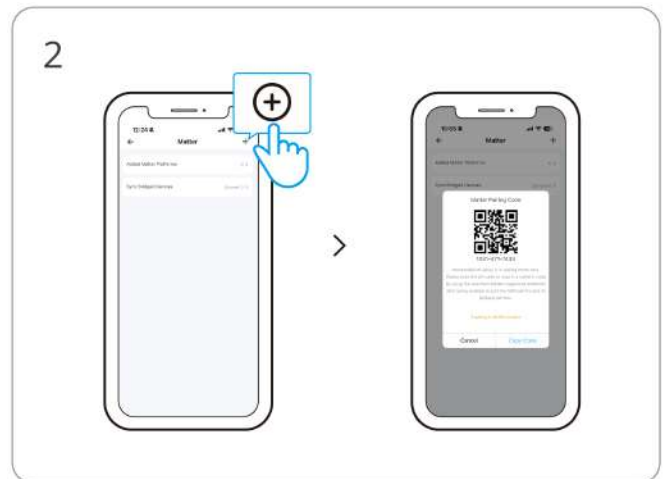

Use a third-party Matter-compatible app to scan the Matter pairing code or enter the numeric code to complete pairing.

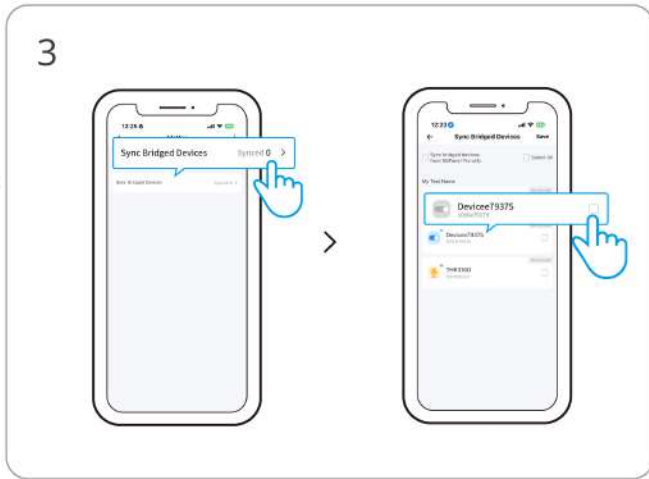

In the device sync management section, select the devices under your eWeLink account and confirm. The selected devices will be synced to your Matter ecosystem.

## F-Droid

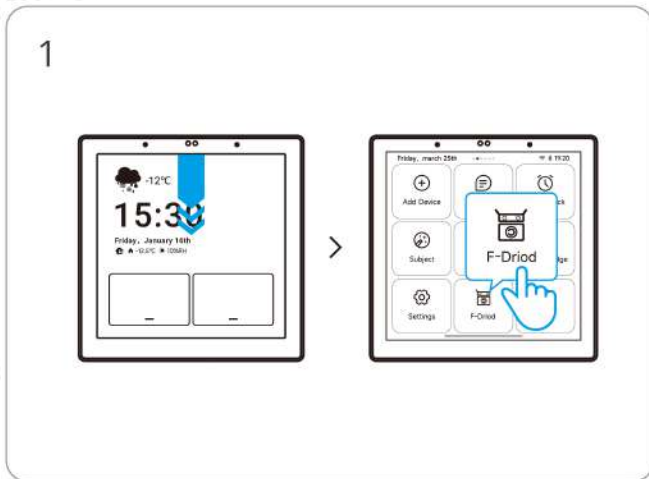

Swipe down on the screen and select "F-Droid" to search for apps.

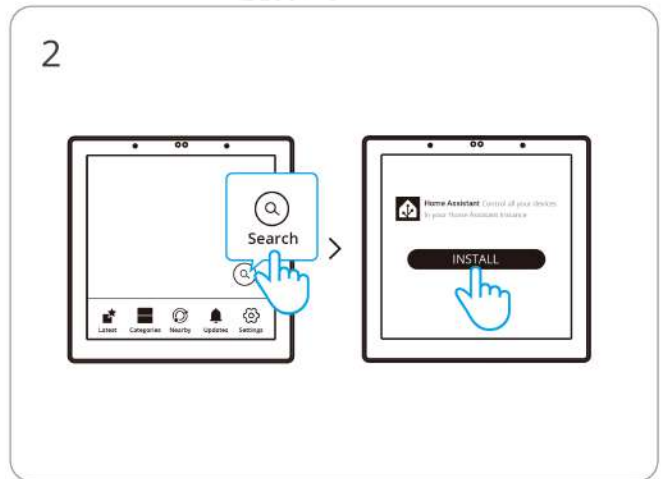

Download and install the desired app, then launch it to start using.

## Home Assistant App as Home App

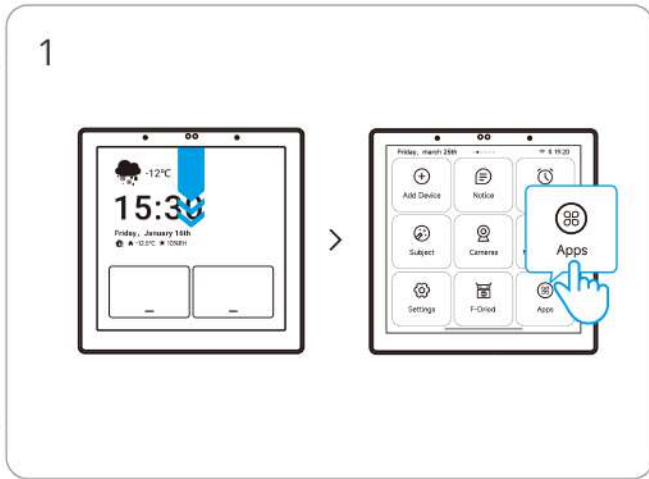

Swipe down on the screen, tap "Apps" to enter the app selection interface.

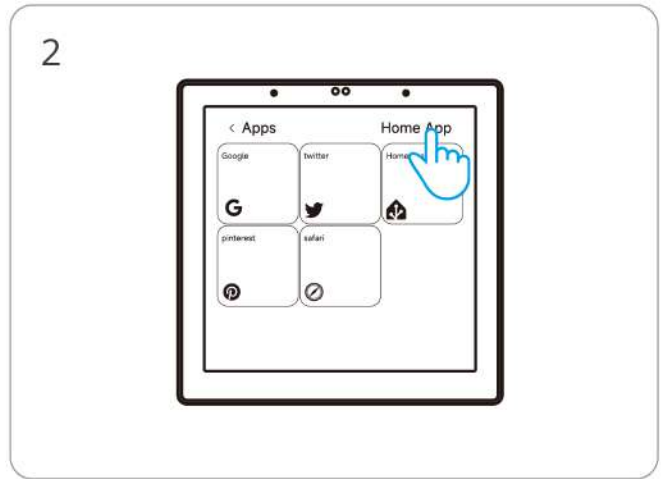

Select "Home App", then choose "Home Assistant" from the app list and confirm.

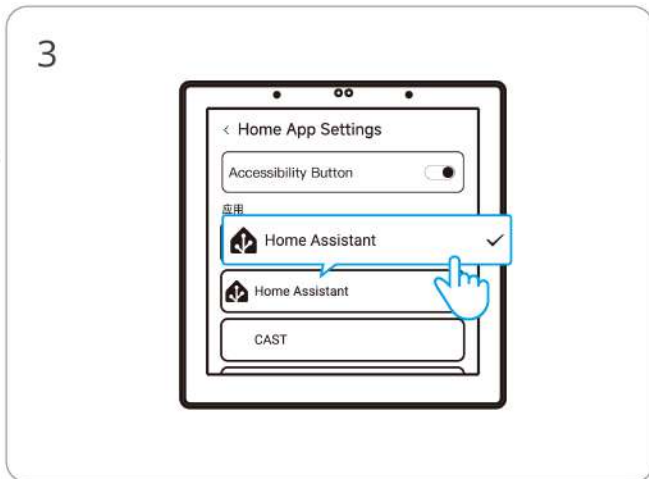

Choose "Home Assistant" and confirm to set it as the default Home App, accessible directly from the main screen.

\*Other apps can also be set as the default home screen app.

## Enable & Add Central Heating

### Enable Central Heating:

#### Method 1:

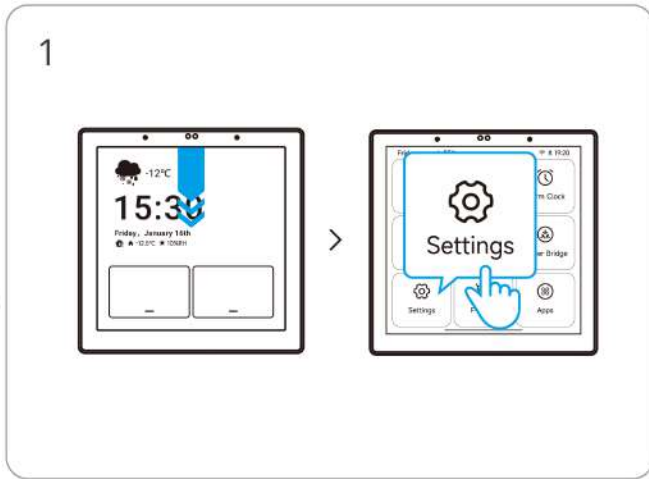

NSPanel Pro Gen2 Screen > Drop-down Menu > Settings

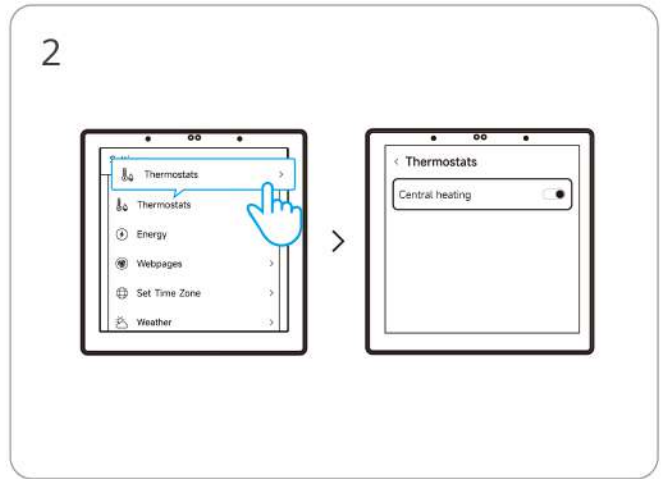

Thermostats > Central Heating, set to "Enable".

**Method 2:**



eWeLink App > NSPanel Pro Gen2 > Screens

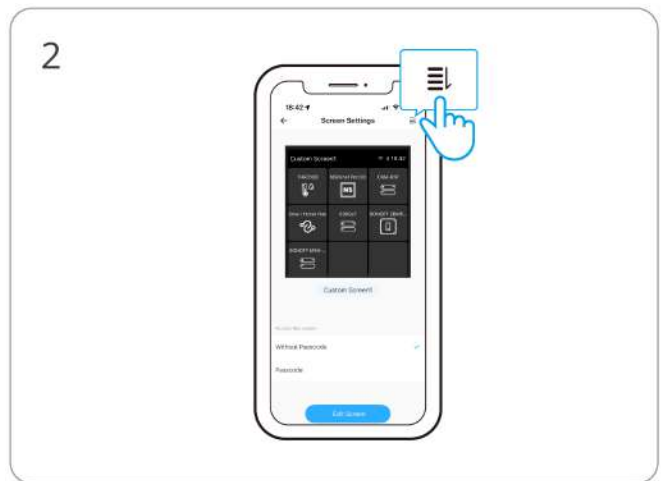

Tap the split-screen sort icon in the top right corner.

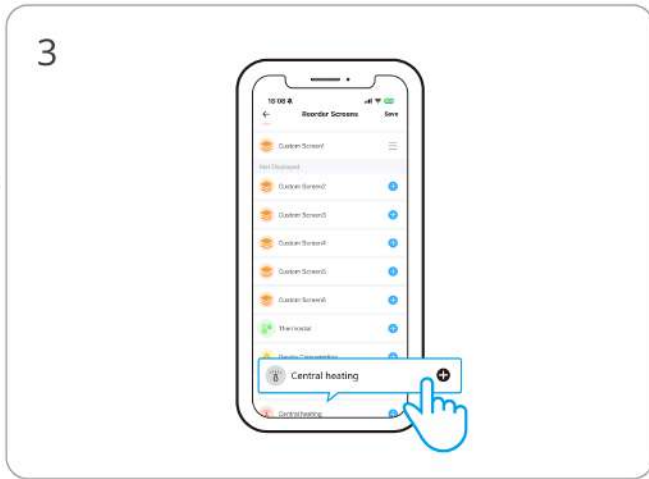

Set the "Central Heating" to display.

### Add Central Heating:

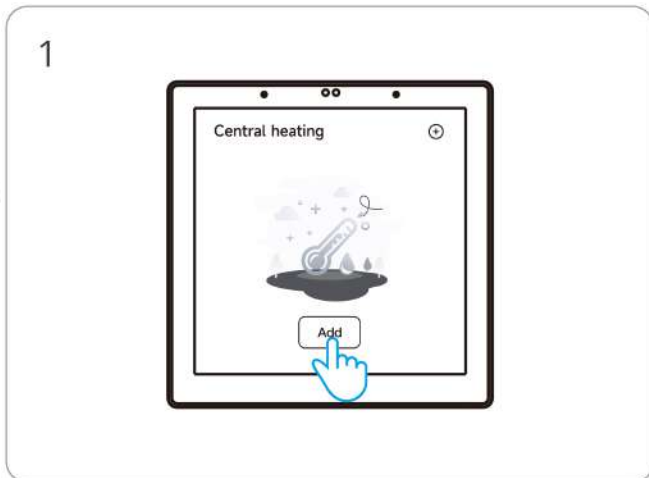

On the NSPanel Pro Gen2 screen, enter the "Central Heating" split screen, tap "Add".

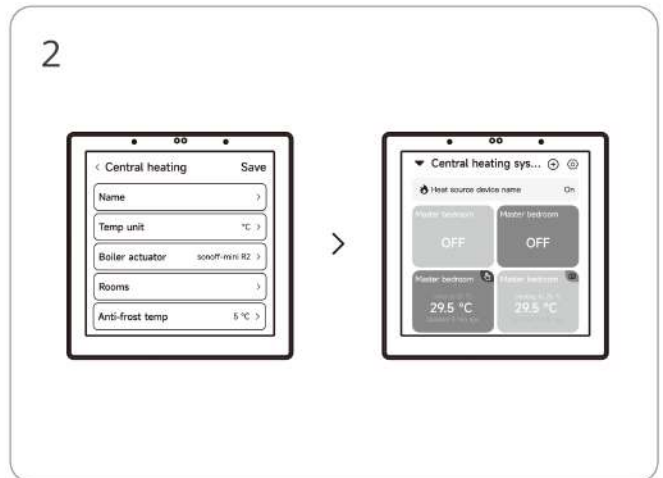

Follow the on-screen instructions to complete the setup to control the room temperature.

### Add Camera & View Camera

#### Method 1: Add Camera via the NSPanel Pro Gen2 Screen

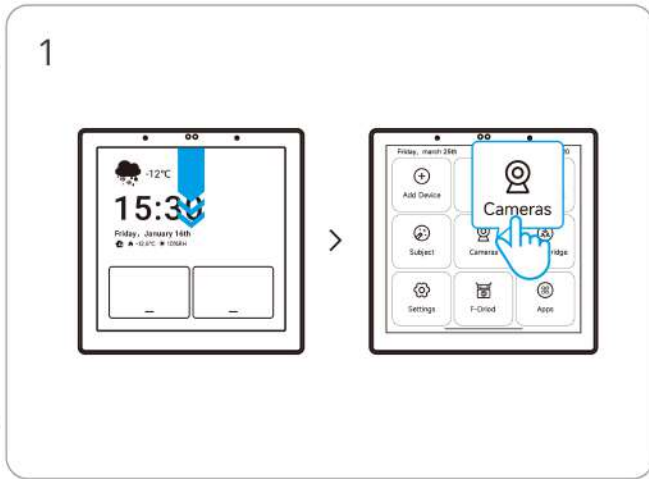

Select "Cameras" from the drop-down menu.

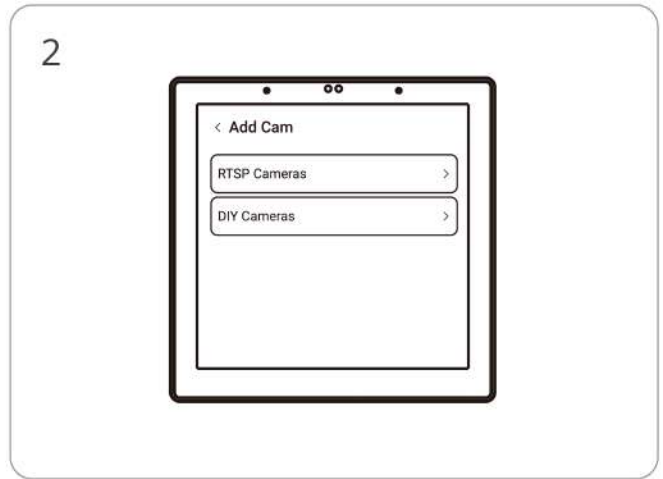

Choose to add an RTSP camera or a DIY camera according to the on-screen instructions.

## Method 2: Add Camera via the eWeLink App

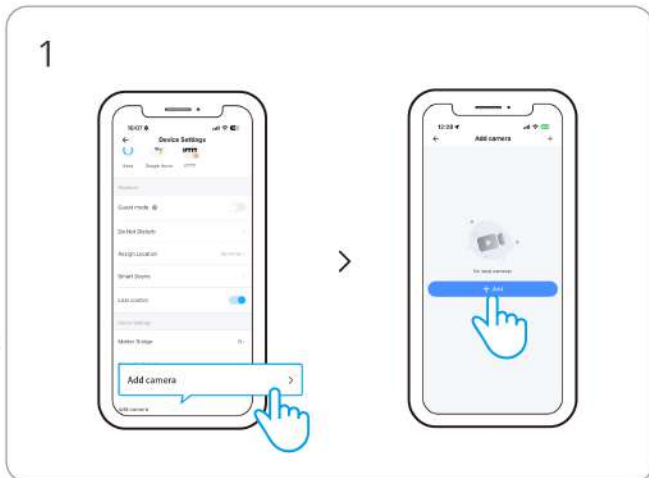

eWeLink App -> NSPanel Pro Gen2 -> Settings Page -> Add Cameras.

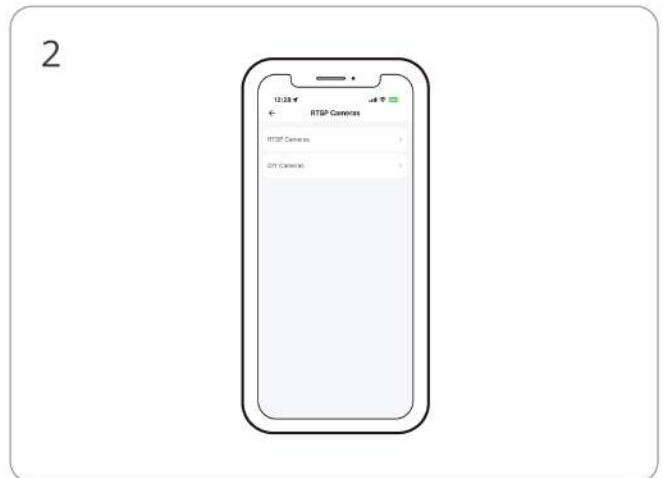

Choose to add an RTSP camera or a DIY camera according to the on-screen instructions.

## View Camera Feed

View the camera feed on the NSPanel Pro Gen2 screen.

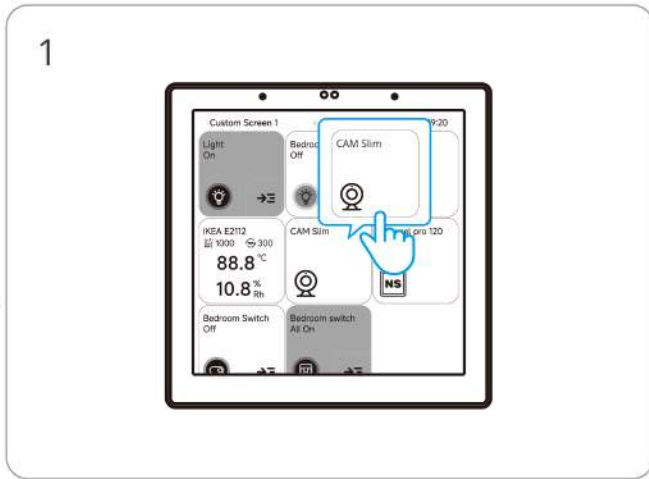

1 Select the added "Camera" device, such as "CAM Slim".



2 Instantly view the live camera feed on the screen.

## Smart Security

There are 3 modes of Smart Security, home mode, away mode and sleep mode. Select the mode on the App to enable the triggerable sub-devices and set the alarm sound.

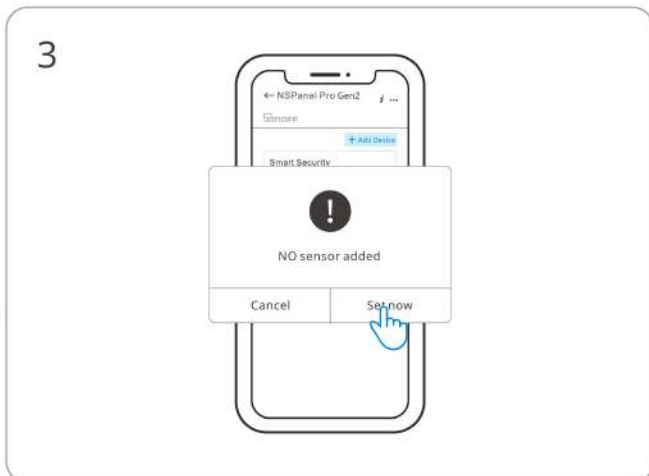
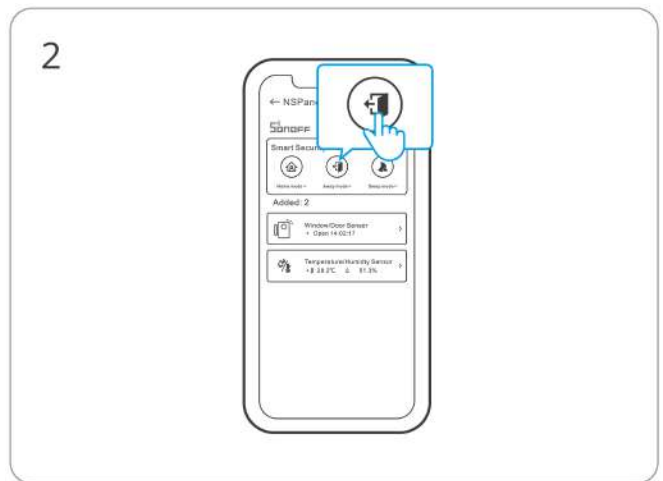
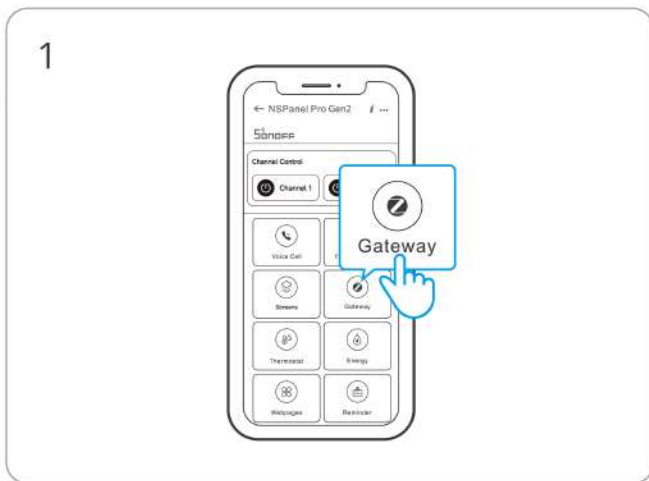

\*The smart security functions can only be used after adding security sub-devices (door/window sensors, motion sensors, water leak sensors, wireless buttons).

If security sub-devices have already been added, the operation steps are as follows:

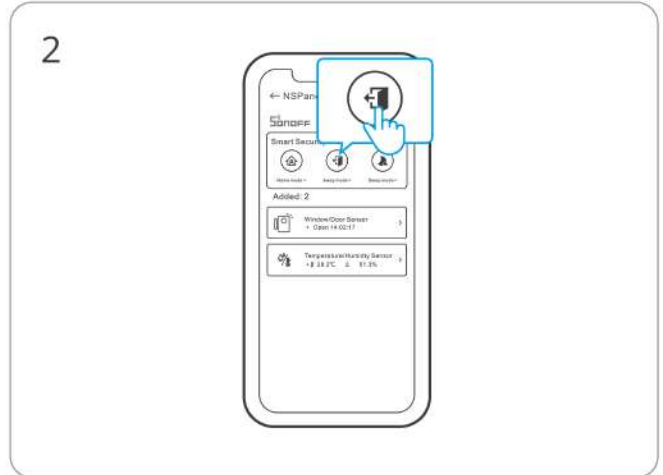
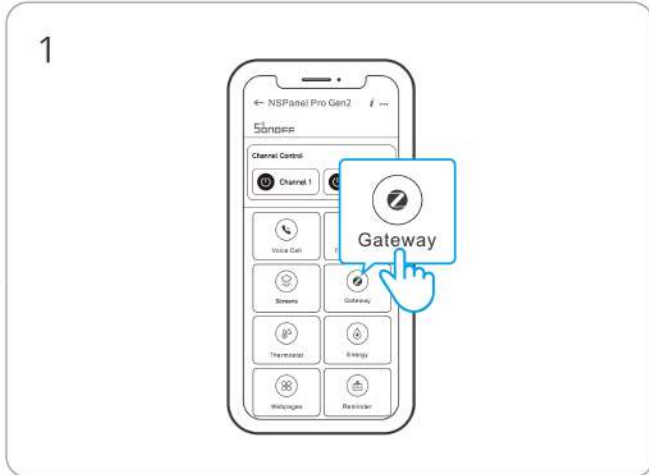

## Factory Reset

### Method 1:

Deleting the device on the eWeLink App indicates you restore it to factory setting.

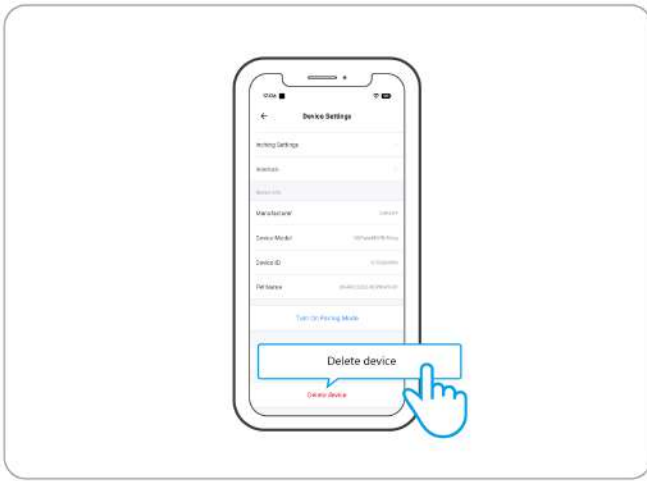

## Method 2:

Complete the factory reset follow the prompts on the panel.

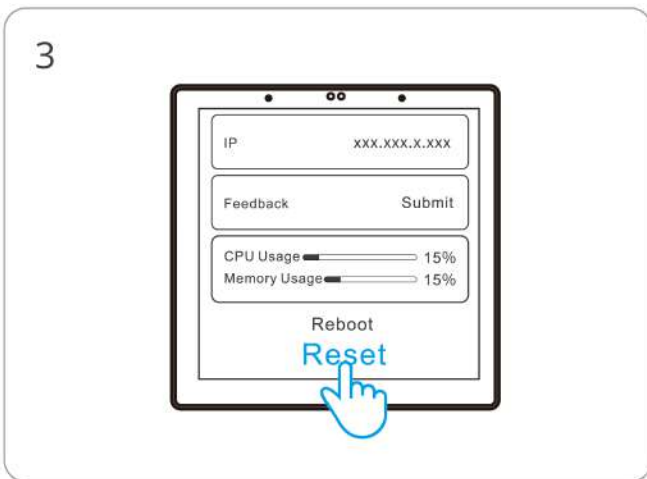
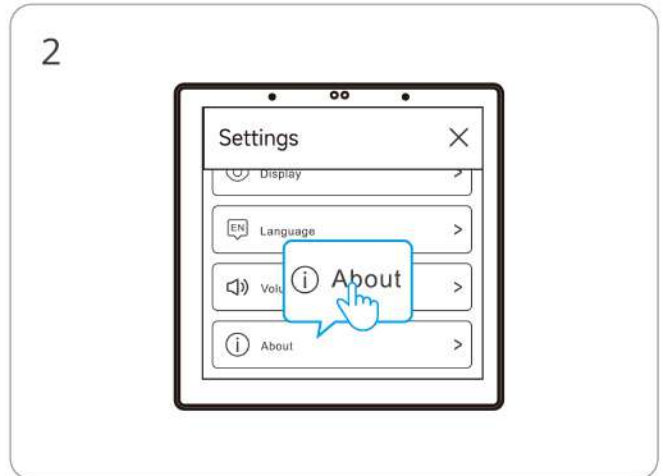
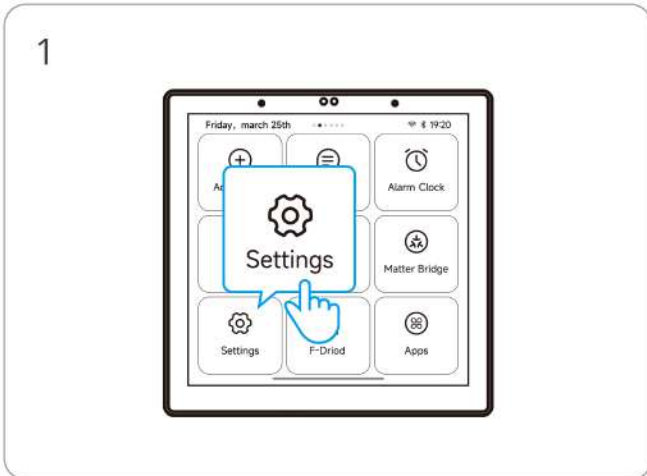

# EU Declaration of Conformity

Hereby, Shenzhen Sonoff Technologies Co., Ltd declares that the radio equipment type NSPanel86PB-Relay, NSPanel86PW-Relay is in compliance with Directive 2014/53/EU. The full text of the EU declaration of conformity is available at the following internet address:

<https://sonoff.tech/compliance/>.

## For CE frequency

### EU Operating Frequency Range

Wi-Fi: 802.11 b/g/n20 2412–2472 MHz, 802.11 n40:2422–2462 MHz, 802.11a/n/ac/ax 5150–5250 MHz, 5725–5850 MHz

BLE: 2402–2480 MHz

Zigbee: 2405–2480 MHz

### EU Output Power

Wi-Fi 2.4G  $\leq 20$ dBm

Zigbee 3.0  $\leq 10$ dBm

BLE  $\leq 10$ dBm

Wi-Fi 5150–5250MHz  $< 23$ dBm

Wi-Fi 5725–5850MHz  $< 14$ dBm

5G is only available indoors.

Under normal use of condition, this equipment should be kept a separation distance of at least 20 cm between the antenna and the body of the user.

Scatola	Scatola	Manuale	Neto	Borsa
PAP 20	PAP 21	PAP 22	EVA 7	LDPE 4
Carta	Carta	Carta	Plastica	Plastica
RACCOLTA DIFFERENZIATA				

Verifica le disposizioni del tuo Comune.

Separa le componenti e conferiscile in modo corretto.

## WEEE Disposal and Recycling Information



All products bearing this symbol are waste electrical and electronic equipment (WEEE as in directive 2012/19/EU) which should not be mixed with unsorted household waste. Instead, you should protect human health and the environment by handing over your waste equipment to a designated collection point for the recycling of waste electrical and electronic equipment, appointed by the government or local authorities. Correct disposal and recycling will help prevent potential negative consequences to the environment and human health. Please contact the installer or local authorities for more information about the location as well as terms and conditions of such collection points.

# SONOFF

**Manufacturer: Shenzhen Sonoff Technologies Co., Ltd.**

Address: 3F & 6F, Bldg A, No. 663, Bulong Rd, Shenzhen, Guangdong, 518000, China

Service email: [support@itead.cc](mailto:support@itead.cc) Website: [sonoff.tech](http://sonoff.tech)

Made in China



FR

Cet appareil et ses accessoires se recyclent

À DÉPOSER EN MAGASIN



OU

À DÉPOSER EN DÉCHÈTERIE



Points de collecte sur [www.quefairedemesdechets.fr](http://www.quefairedemesdechets.fr)  
Privilégiez la réparation ou le don de votre appareil !



